

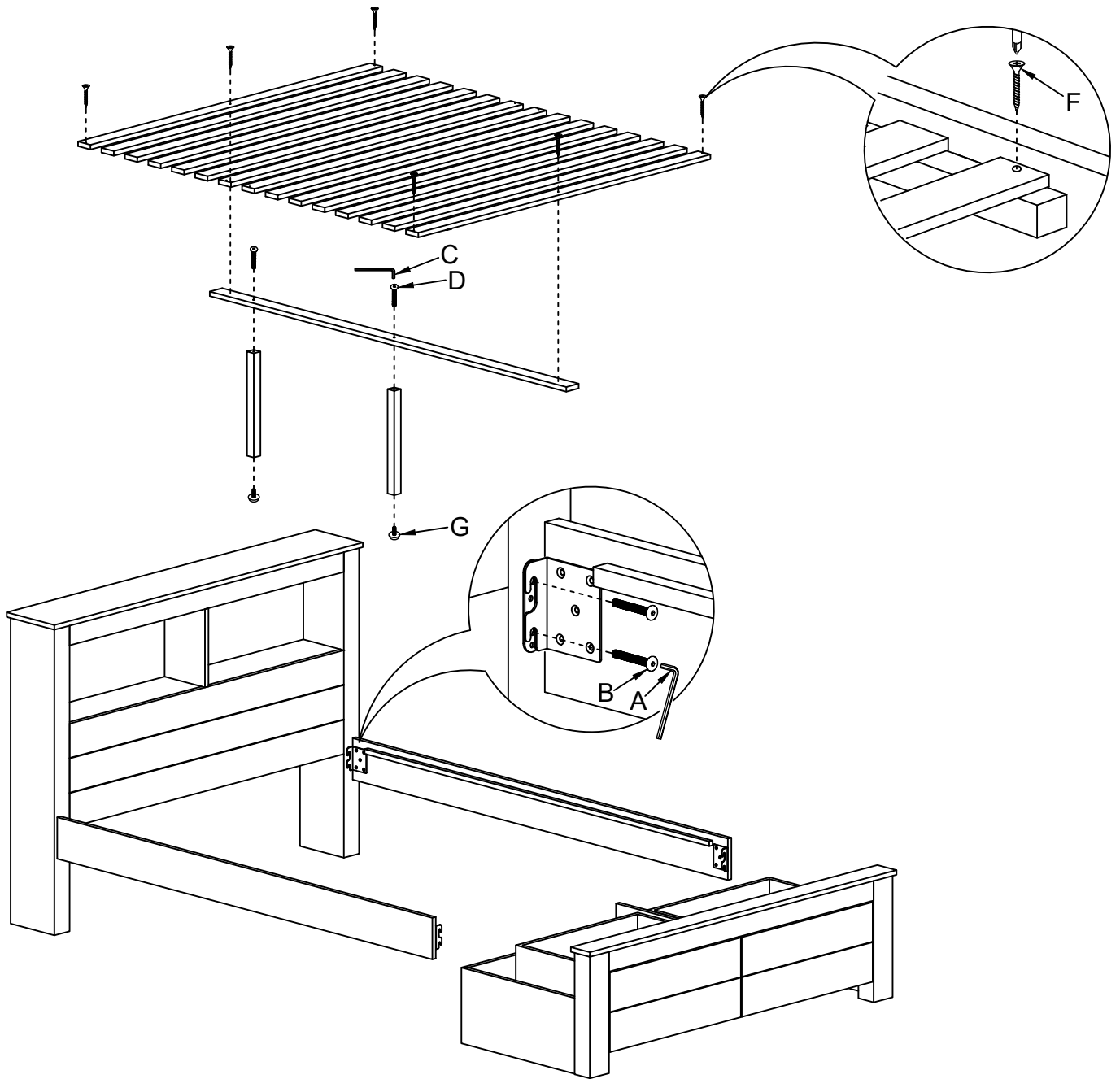

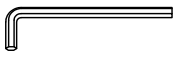



ASSEMBLY INSTRUCTION

Thank you for purchasing this quality product. Please check all packing material carefully which may have come loose inside the carton during-shipment. Identify and count all parts referring to the Part List below.

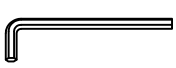

HARDWARE LISTS

| NO | DESCRIPTION | QTY |
|----|--|-----|
| A |  ALLEN KEY M5 | 1 |
| B |  JCBB BOLT M8 50MM | 8 |
| C |  ALLEN KEY M4 | 1 |

| NO | DESCRIPTION | QTY |
|----|---|-----|
| D |  JCBC BOLT M6 30MM | 2 |
| F |  CSK SCREW M4 32MM | 6 |
| G |  ADJUSTABLE LEG | 2 |